



AlluGuard

style, security, innovation...

Welcome to your
guide to the very
best garage doors



Secured by Design



Police Preferred Specification



the
GARAGE
DOOR
CHANNEL

watch AlluGuard online at: www.thegaragedoorchannel.co.uk



Insulated Roller Garage Doors

page 4



Insulated Sectional Garage Doors

page 26

What's important
when it comes to
choosing a new
door?



Read on... or watch online at:
www.thegaragedoorchannel.co.uk





AlluGuard

style, security, innovation...

Security?

Insulated Roller Doors page 8
Insulated Sectional Doors page 30

Insulation?

Insulated Roller Doors page 10
Insulated Sectional Doors page 32

Convenience?

Insulated Roller Doors page 12
Insulated Sectional Doors page 34

Colours?

Insulated Roller Doors page 14
Insulated Sectional Doors page 36

Remote Control?

Insulated Roller Doors page 16
Insulated Sectional Doors page 39

Trusted and quality assured

AlluGuard is totally focussed on you. Choosing a product for your home as important as a garage door is not something you do very often. Perhaps only once or twice in a lifetime!

To purchase with confidence requires a company you can trust - a quality assured company.

AlluGuard's reputation is built on quality and we are independently certified to prove that our quality management systems are industry acknowledged! Our products are designed to give you the ultimate in performance ensuring that you'll be happy to recommend AlluGuard.

Safety always comes first at AlluGuard. All our products carry a CE mark and have been independently tested for safe operation and compliance with legislation to EN 13241-1.



Buy with confidence!



Insulated Roller Garage Doors



AlluGuard 77

AlluGuard 55

No other door
is quite like an
AlluGuard door!



Insulated Roller Garage Doors

Insulated roller garage doors are wonderfully simple in everyday use thanks to smart technology. Over the coming pages we'll introduce the clever features on AlluGuard insulated roller garage doors, but by way of introduction here are the highlights:

How easy is that!

They open at the touch of a button.



Smart controls ensure safe and effortless opening every time.

They are Police Approved



for security. Protect valuable items stored in your garage with our independently tested Secured by Design door, the AlluGuard77.

They take up less space



than any other garage door, rolling up into a compact space with no tracks projecting into the garage.



They make extra space



by fitting behind the opening giving you a wider and taller opening. This increases drive-through width by up to 150mm (6") and drive-through height by up to 75mm (3") Vertical opening means the door doesn't project out onto your drive or into the garage space allowing you to park up to the door, inside and out.

They keep out the weather



so your garage is no longer a draughty no-go area.

Read on... or watch online at:
www.thegaragedoorchannel.co.uk



Everything works at just the touch of a button these days!



They look simply stunning



The gentle curve and the subtle lines of each slat are finished in a tough polyester powder coating or a high grade laminate to create an overall look that is classic and contemporary in equal measure.

They are covered by fair warranties



AlluGuard roller doors are covered by a comprehensive warranty of two and five years - see the back page for full details.



They are quality assured & safe



Every door is manufactured to our ISO 9001 certified quality systems and CE certified and marked as safe to Directive EN 13241-1.

AlluGuard 77 & AlluGuard 55 -

What's the difference?

All the features only smaller! AlluGuard 55 uses a smaller slat that allows it to roll tighter requiring less space at the top of the door. It's the ideal choice when headroom is especially limited.



Security



Security Matters

Bikes, fitness equipment, tools... whatever you keep in your garage in addition to your car, it's always a surprise when you add up the value - often several thousand pounds! To keep your possessions secure look for the Secured by Design symbol - the only form of national Police accreditation for security - you'll find it on our AlluGuard 77 garage door.

Secured by Design

AlluGuard77 is designed to be secure and has been awarded the Secured by Design Police Preferred Specification status. To achieve Secured by Design, doors are independently tested and certified to the standard, giving you peace of mind that your new garage door is secure to a Police approved standard.

Alarmed

The door control unit for AlluGuard 77 and 55 doors employs magnetic contacts on the bottom of the door to monitor the door's position when locked. If an attempt is made to lever the bottom of the door upwards a piercing alarm is triggered to deter intruders.



The locking ring that holds the door curtain in the closed position and pulls the door curtain upwards, is a huge improvement over the conventional method other manufacturers use.



Heavy duty extruded aluminium guides secure the door at the sides.

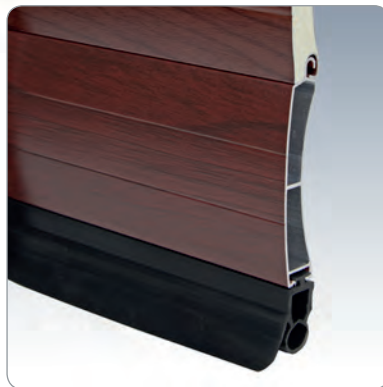

The extruded aluminium bottom slat adds extra strength to resist forcing. See page 17 for notes on colours.

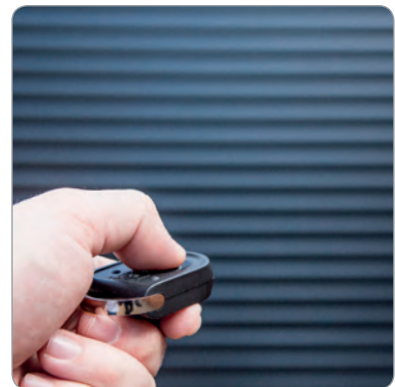

Remote control means there's no external lock to pick or attack.

What is Secured by Design?

Secured by Design (SBD) is the UK Police flagship initiative that is founded on the principles of designing out crime and crime prevention.

SBD supports one of the Government's key planning objectives: the creation of secure, quality places where people wish to live and work.

Research carried out by Huddersfield University shows that residents living on Secured by Design Developments are half as likely to be burgled and two and a half times less likely to suffer vehicle crime. Secured by Design Developments also benefit from 25% less criminal damage.

Secured by Design



Police Preferred Specification

We store a lot of stuff in our garage so the extra security of AlluGuard's roller door was first on the list for us !



Insulation



Fully Insulated & finished to perfection

AlluGuard is designed to give thermal and acoustic insulating properties much higher than the average garage door.

'CFC' Free Polyurethane Foam within the Aluminium Lath plus high performance weather sealing ensures good insulation.

It's perfect if you want to use your garage as a work/play room or your garage is under a bedroom.

The corrosion resistant aluminium laths are light yet strong and can be finished in a range of solid colours or woodgrain textures - see pages 14-15.



77

55

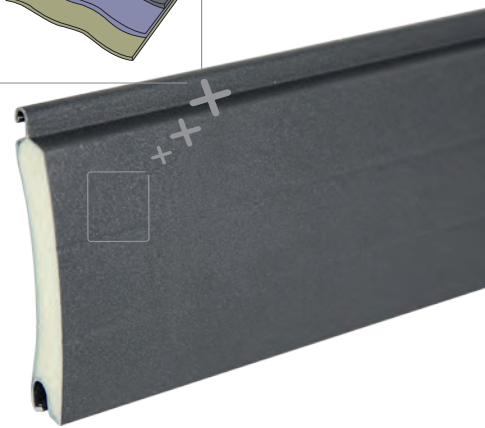

Brush strips reduce draughts and the bottom seal keeps out wind blow debris.



Bedrooms over your garage? Help keep the chills out with insulated lath and advanced weather sealing.



Keeping my home warm is top of my list of priorities!



Home gym? Why not!

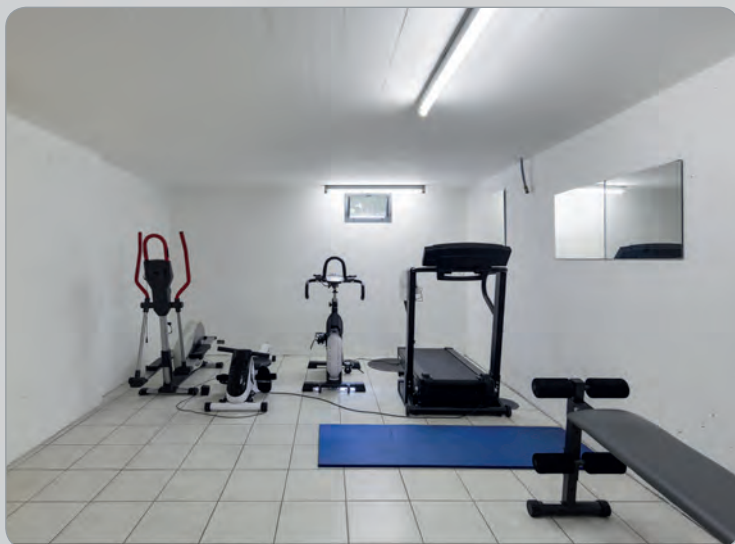

Being able to park right up is a huge benefit to me!



Doors can be fitted externally if headroom is very limited inside the garage. The roll box will be visible and the concave face of the door slats faces outwards.

Convenience

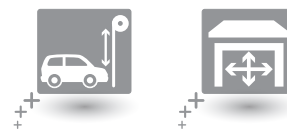

No wasted space

Roller garage doors operate vertically, rolling into a compact coil within the garage, above the opening. Not only does this mean you can park right up to the garage door, but valuable space is not taken up inside your garage which could be used for storage.

Takes up less space

Because it rolls 'tighter' than other roller doors, AlluGuard takes up less headroom when open - just 300mm for the AlluGuard 77 and even less for AlluGuard55 at 205mm.

The door typically sits behind the brickwork, allowing any existing frame to be removed. This increases drive-through width by up to 150mm (6") and drive-through height by up to 75mm (3")

This, and its very compact side runners, gives you much more room to manoeuvre.

Doors can even be fitted externally where headroom is extremely limited.

Good looks inside and out

The outside of the door is simply stunning, the inside equally impressive. Whether you choose a powder coated door with matching guides and box or a laminated door with Mocca brown guides and box, the installation is incredibly neat and compact – no wasted space inside your garage!



The neat inside is made even tidier with the option of a box to house the door roll.



Extra drive through width of up to six inches - 150mm helps keep your wing mirrors unmarked!

Solid colours

Low maintenance powdercoat finishes for AlluGuard77 garage doors are available in these stylish colours:

* Denotes non-stock colour options

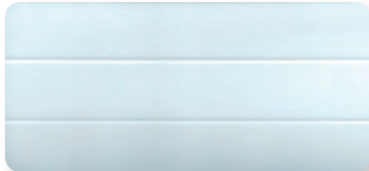

White RAL 9016



Cream RAL 9001



Home Cream RAL 1015

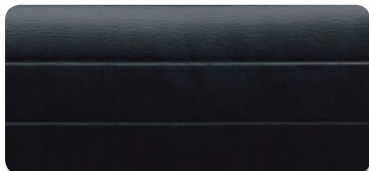

Black RAL 9011

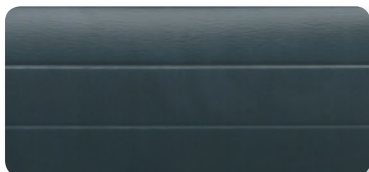

Anthracite Grey RAL 7016

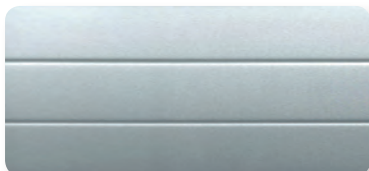

*Silver RAL 9006

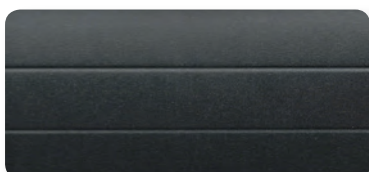

Graphite

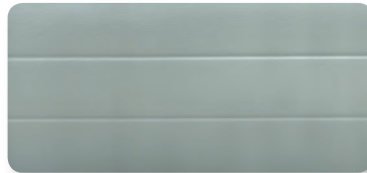

*Pale Grey RAL 7038



Burgundy RAL 3004



Ruby Red RAL 3003

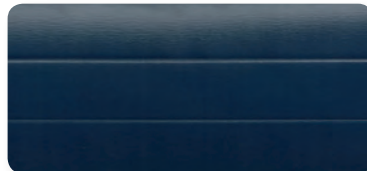

Blue RAL 5011

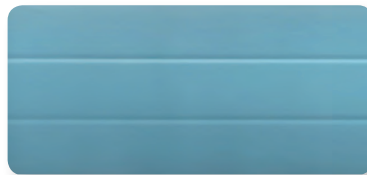

Duck Egg Blue BS 16 C 33



Chartwell Green BS 14 C 35



Racing Green RAL 6009



*Moss Green RAL 6005

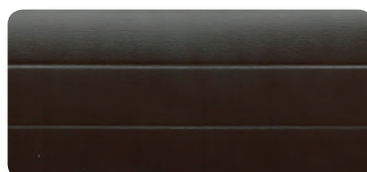

Mocca Brown RAL 8019

Wood effect painted

Low maintenance wood effect powdercoat finishes for AlluGuard77 door are available in the following wood shades:

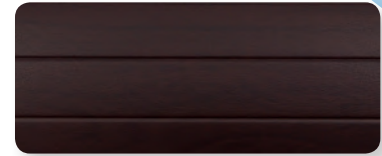

Rosewood Painted

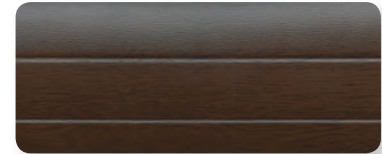

*Walnut Painted

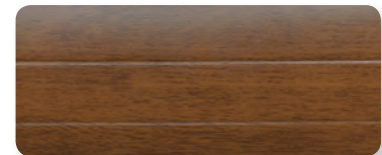

Golden Oak Painted



*Irish Oak Painted

Wood effect laminate

Low maintenance wood effect laminate finishes for AlluGuard77 door are available in the following wood shades:



Mahogany



Golden Oak



Rosewood

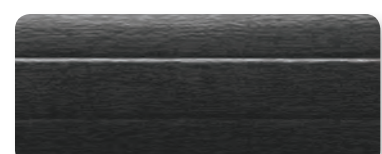

Black

Notes on colours

Coloured guide rails are supplied as standard, however, they may not perfectly match the lath colour. The manufacturing process for the lath profile results in a textured finish, whilst all other coloured items (guides, bottom laths, lock laths, optional fascias and vision panels) are supplied in a satin finish, so cannot be guaranteed to match exactly. Over time some scuffing / pressure marks may occur on front and rear surfaces of doors as a result of their normal operation.

Colours shown are for guide purposes only and are limited by the printing process. Please ask to see a colour sample to confirm your choice.

AlluGuard 77

I want my garage door to match my windows!

Colours

AlluGuard's wide choice of finishes ensure your new garage door not only looks good for years to come, but also complement the look of your home.

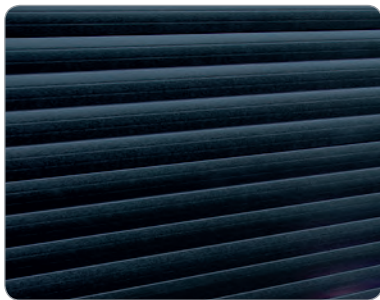

The door curtain

The door curtain is available powdercoat finished in the solid colours and wood effects and wood effect laminate shown left.

The rear of the door slats is finished to match the front on powdercoated doors and in white on wood effect laminates.



The door guides

The guides are finished to match the door curtain colour on all solid powdercoat colours. Wood effect powdercoat and laminate doors are supplied with Mocca Brown guides. Rosewood and Golden Oak wood effects are available with a complementing powdercoat finish as an option.



The door roll box

Doors are supplied without a roll box as standard but are available as an option with a half or full roll box. These can be finished as an option to match the door curtain and guides for all solid colours and Rosewood and Golden oak. Irish Oak, Walnut and Mahogany are finished in Mocca Brown.



The standard configuration is with no roll box.



The half box option helps prevent debris dropping onto the door roll



The full box option encloses the door roll for a very neat installation.



Requiring only 205mm of headroom, the AlluGuard55 has the benefits of the larger AlluGuard77, but in a very compact space.

Solid colours

Low maintenance powdercoat finish for AlluGuard55 garage doors are available in these classic colours:



White RAL 9016

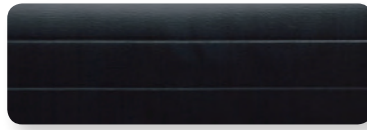

Black RAL 9011

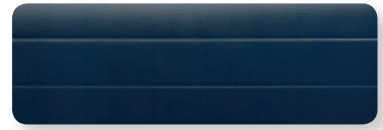

Blue RAL 5011



Cream RAL 9001

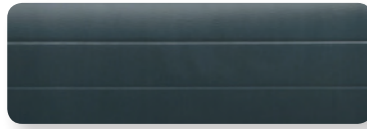

Anthracite Grey RAL 7016

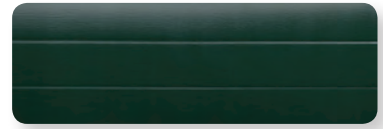

Racing Green RAL 6009



Home Cream RAL 1015

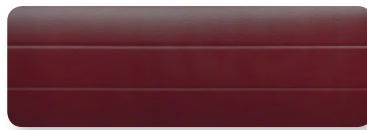

Burgundy RAL 3004

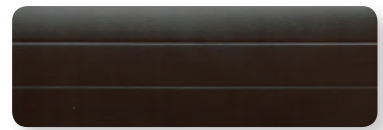

Mocca Brown RAL 8019

Wood effect laminate

Low maintenance wood effect laminate finishes for AlluGuard55 door are available in the following wood shades:



Mahogany



Golden Oak



Rosewood



The AlluGuard 55 fits in smaller spaces!

Notes on colours

Coloured guide rails are supplied as standard, however, they may not perfectly match the lath colour. The manufacturing process for the lath profile results in a textured finish, whilst all other coloured items (guides, bottom laths, lock laths, optional fascias and vision panels) are supplied in a satin finish, so cannot be guaranteed to match exactly. Over time some scuffing / pressure marks may occur on front and rear surfaces of doors as a result of their normal operation.

Colours shown are for guide purposes only and are limited by the printing process. Please ask to see a colour sample to confirm your choice.

AlluGuard 55

I'm smaller
but perfectly
formed!
AlluGuard 55

Colours

AlluGuard's wide choice of finishes ensure your new garage door not only looks good for years to come, but also complement the look of your home.

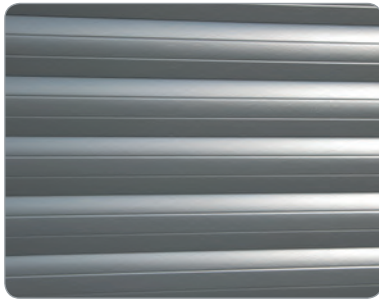

The door curtain

The door curtain is available powdercoat finished in the solid colours and wood effect laminate shown left.

The rear of the door slats is finished to match the front on powdercoated doors and in white on wood effect laminates.



The door guides

The guides are finished to match the door curtain colour on all solid powdercoat colours. Wood effect laminate doors are supplied with Mocca Brown guides. Rosewood and Golden Oak wood effects are available with a complementing powdercoat finish as an option.



The door roll box

Doors are supplied with a half roll box as standard but are available as an option with a full roll box. These can be finished as an option to match the door curtain and guides for all solid colours and Rosewood and Golden oak. Mahogany is finished in Mocca Brown.

Colours shown are for guide purposes only and are limited by the printing process. Please ask to see a colour sample to confirm your choice.



The half box is standard.



The full box option encloses the door roll for a very neat installation.



I want to open my door from the security of my car



Remote Control



Effortless performance

Remote control is a standard feature that makes using your door effortless and secure. No need to get out of your car on a wet and windy night!

Controls to suit you

With a range of controls available, choosing the ideal way to operate your doors couldn't be easier. Remote control, wall switch, keypad... see page 22 for the full range of options.

The control unit

The Rollixo RTS wireless or the Sommer wired control unit is the doors' "brain". It responds to signals from the remote control and other accessories to operate the door.

It has an integrated courtesy light to guide your way and buttons to operate the door. It also houses the intruder protection alarm that sounds when attempts are made to force the door by levering up the bottom slat.

HOME MOTION by
somfy



SOMMER

All AlluGuard garage doors come with the following:

- Rollixo RTS Wireless Control Unit
- 2 Keygo RTS Keyfobs
- Electrical Wireless Safety Edge / Optical Wired Safety Edge

OR:

- Sommer Wired Control Unit
- 2 Sommer Keyfobs
- Optical Wired Safety Edge

Remote control

Compact, stylish and keyfob friendly, the Somfy or Sommer remotes control your doors and can also be programmed to control gates, lights and more in one stylish handset. Two are supplied as standard and more can easily be added.



Safety Edge

Peace of mind protection for you and your family. The doors' bottom edge rubber seal incorporates an electric or optical sensor along its length to detect obstructions and instantly stop and reverse the door a short distance when closing.

Wireless and wired versions are available certified and marked as safe to Directive EN 13241-1.





1 Power fail override

If the power fails a simple hand crank is used to operate the door.



2 External Power fail override

An optional external crank with lockable access is also available should there be no other access to the garage.



3 Keeps out the weather

Weather resistance is excellent with a rubber compression seal to the bottom of the door and a brush strip within the guides.

Features at a glance

AlluGuard takes the concept of the roller garage door to a new level. It out-performs the ordinary garage door for ease of use, insulation, finishes, safety and security and all doors are manufactured

under strict and controlled guidelines. More and more homes are benefiting from an AlluGuard roller garage door - take a look at the features that make all the difference:



4

Smooth & quiet

Felt on the barrel rings help reduce marking to the door curtain over time and reduce operating noise.



5

Safe

The safety edge stops and reverses the travel of the door on contact with an obstruction.



6

Powerful

Concealed within the barrel of the door is a powerful and quiet motor that drives the door and holds the curtain locked when closed.



7

AlluGuard 77

AlluGuard 55

Secure

Security is excellent with strong locking straps that prevent forced lifting of the door.



8

Complete control

The wall-mounted control unit has a courtesy light to guide your way and push button control for the door. The alarm is also housed in the control unit that sounds on an attempt to force up the door from the bottom slat.



9

Safety brake

A safety brake is fitted to every AlluGuard 77 door that will prevent the door from dropping in the unlikely event of a motor failure.

Automation Accessories

HOME MOTION by **somfy**

Automated as standard, the features of the AlluGuard77 and AlluGuard55 garage door systems are already at a luxury level. To further enhance day-to-day use this range of control options provides extra flexibility.



TaHoma Hub

The Somfy TaHoma hub allows control of your garage door and other compatible home items from your tablet, pc or smart phone. The door must be in line of sight to ensure safe operation.



Radio Wall Switch

This wall mounted wireless switch can be installed inside the garage or home for easy operation of your garage door. Also available wired.

Lockable Override Cover

A lockable cover to protect the manual override access point on externally fitted doors.

Rocker Switch

This wall mounted wired rocker switch can be installed inside the garage or home for simple operation of your garage door.



Smooove Wall Switch

The Somfy remote control, available in single and double fittings, add touch sensitive controls to your new door system.

Available in three colours, you can customise the look and feel of the control unit to match your surroundings.



Wired Key Switch

This externally wall mounted key switch allows operation without the use of a hand transmitter and is an alternative to our keypads.



Standard Receiver RTS

The waterproof standard receiver allows keyfobs, keypads and key switches to effortlessly control your outdoor lighting, gate, etc.

Can be externally mounted.



Keygo Remote

Two Keygo 4 RTS remote controls are supplied with every door. Extra remote controls can be added and are easy to programme.



Secure Metal Keypad (IP54)

Introducing our new anti-vandal keypad for secure garage door operation.

With a metal case and secure smart rolling code technology, this keypad gives you peace of mind for secure access to your garage.



Wireless Digital Keypad

This externally wall mounted keypad will accept a 4 to 13 digital code to operate your garage door for opening and closing without the hand transmitter. This makes for a secure method of operation where access is required.

Lighting Slim Receiver RTS

Available as an optional upgrade, our new slim receiver connects a light to the mains power supply to allow control from an RTS control unit.



SOMMER



Pearl Vibe Remote

Two Pearl Vibe remote controls are supplied with every door. Extra remote controls can be added and are easy to programme.

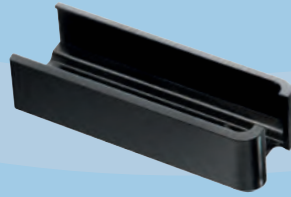

Holder for 4 button handsets

Wall mount a handset with this simple holder.



ENTRAsys GD Finger Print Scanner

Your fingerprint gives you access - store up to 80 finger prints.



Telecody+ Digital wireless key pad

Just punch in the code and the door opens without the need for a handset.



Battery Backup (all doors)

Allows your door to operate for 6-10 operations over a 12 hour period during a power-cut.

Accessories

Door options



Vision slats

Polycarbonate clear glazing is available for AlluGuard77 (doors on a proportion of the door curtain) to allow natural light into the garage.

Woodgrain finish doors are only available with brown vision laths.

Glazing option not available on AlluGuard55.



Curtain roll box

Half and full boxes are available to suit AlluGuard77 doors. Either option will take up 300mm headroom on top of the guide height.

AlluGuard55 doors are supplied with half box as standard. Both half or full box has 205mm headroom on top of the guide height.



Vented laths

Vented laths are available in powder coated colours only.



Manual Exterior Release

For use in emergencies or in the event of power failure. The manual release allows the door to be opened manually from outside the garage - essential if the garage has no other entry point.



Technical

AlluGuard 77

AlluGuard 55

Height measurement guide

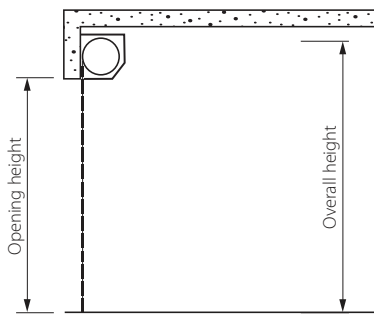

Width measurement guide

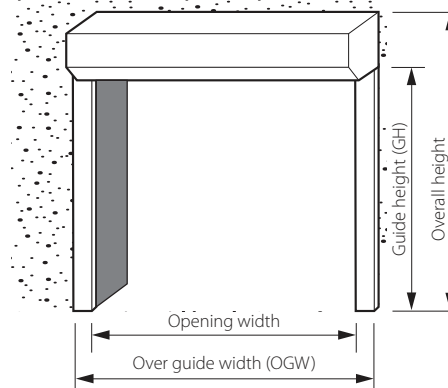

Box end details

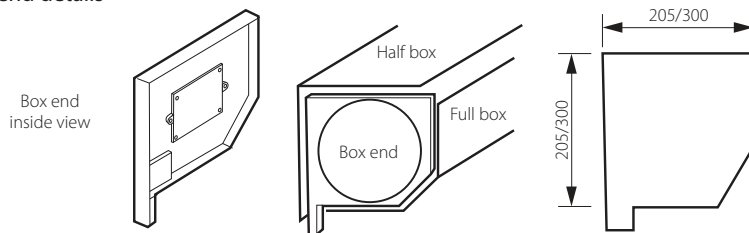

Full and half box (optional extra)

Guide specifications

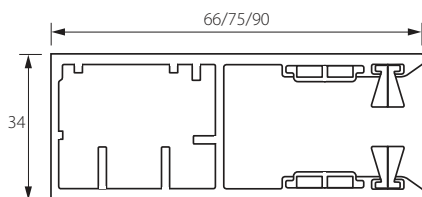

Fixing options

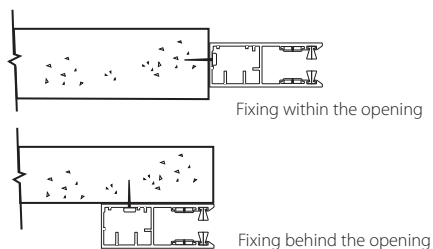

Insulated Sectional Garage Doors





An AlluGuard
garage door is the
perfect addition
to your home!

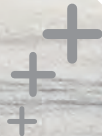

Sectional Garage Doors

Insulated sectional garage doors provide exceptional performance when it comes to insulation and draught reduction. They're not short on good looks either! Over the coming pages we'll introduce more of the benefits of AlluGuard insulated sectional garage doors, expanding on the snapshot shown here:

How easy is that!

Great design

Great styling choices and finishes to suit your home make these doors very versatile. Traditional, classic or contemporary, there's a style to suit.



Safe

The finger safe design ensures that fingers cannot be caught or trapped between the panels, offering complete peace-of-mind.



Anti spring break devices ensure safety. Every door is CE Marked as fully compliant with all European Safety Directives.

Ultimate space saver

Opening vertically you can make the best use of your garage and driveway whilst gaining extra inches of drive through width and height.



They keep the weather out

Substantial seals reaching into the opening at the top, sides and bottom of the door offer greater protection against wind and rain and provide an all-weather superior seal for your home.



Security built in

The security & locking system built into the AlluGuard Sectional ensures security and peace-of-mind.



Read on... or watch online at:
www.thegaragedoorchannel.co.uk



Remote control
garage door
operation is available
on every door!

Energy efficient

The 40 mm Polyisocyanurate (PIR) insulated door panels provide an insulation value of 0.6 W/m²k, ensuring your home is energy efficient and saving you money. The panels also reduce noise and provide a sound reduction.



Excellent warranties

AlluGuard sectional doors are covered by a comprehensive 10 year warranty - see the back page for details.



Complete convenience

With smooth automatic operation, your unique security code, in-built courtesy light and optional battery backup. The option of bi-directional capability lets you know that the door is closed with an LED indicator.





AlluGuard doors
are designed to
provide secure closure
for your garage

Security

Security matters

It's essential that your new garage door provides a good level of security to protect your possessions and gives you total peace of mind.

AlluGuard Sectional doors are very strong. 40mm thick panels made from twin steel skins combined with a bonded Polyisocyanurate foam core to create genuine strength.

The panel strength works with the steel guide tracks to produce a door that doesn't flex or move once closed. It's an impressive deterrent to would be intruders.

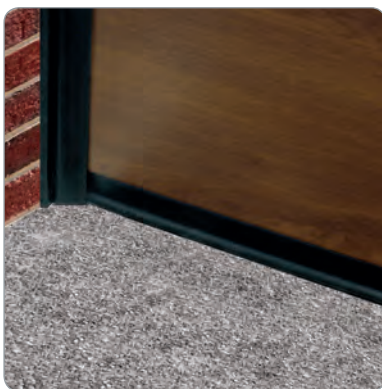

AlluGuard doors are held closed by positive force.



Remote control means there's no external lock to pick or attack.

- Solid "wall", held in place by multiple rollers and full length steel guide tracks.
- AlluGuard power operated doors are held closed by positive force that pushes back against attempts to force the door up.
- Manually operated doors have single locking point secured to heavy steel guides.

Insulation



Fully Insulated & finished to perfection

AlluGuard sectional doors are designed to give thermal and acoustic insulating properties much higher than the average garage door.

Insulated

Our insulated panels are manufactured and finished to the highest quality standards in order to achieve maximum durability. The panel design features a high density, environmentally friendly, CFC-free Polyisocyanurate (PIR) core that is sandwiched between two steel sheets in the finish of your choice, and then coated in one of our extensive range of colours and finishes.

Weather seals

And, with our integrated weather-seals around each edge, there's no need to worry about rain ingress or drafts.

The 40 mm thick insulated panels keep the worst of the weather outside meaning you can make the most of your garage, all year round.

40mm thick insulated panels keep the weather out, making the most of your garage!

Georgian
(Woodgrain)

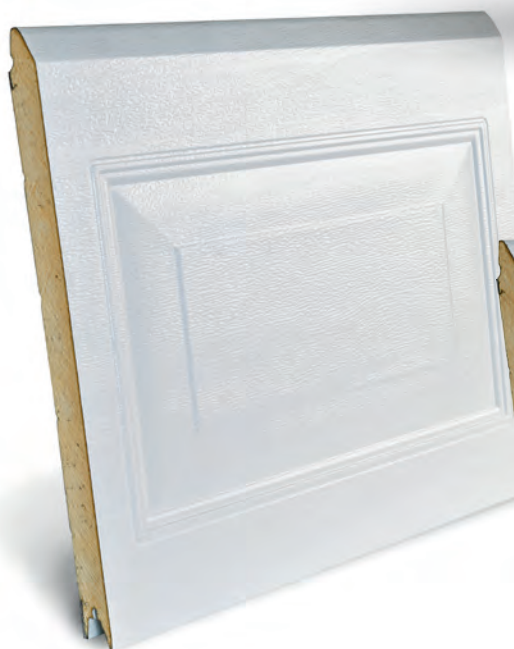

Ribbed
(Woodgrain & Smooth)



Centre Ribbed
(Woodgrain & Smooth)

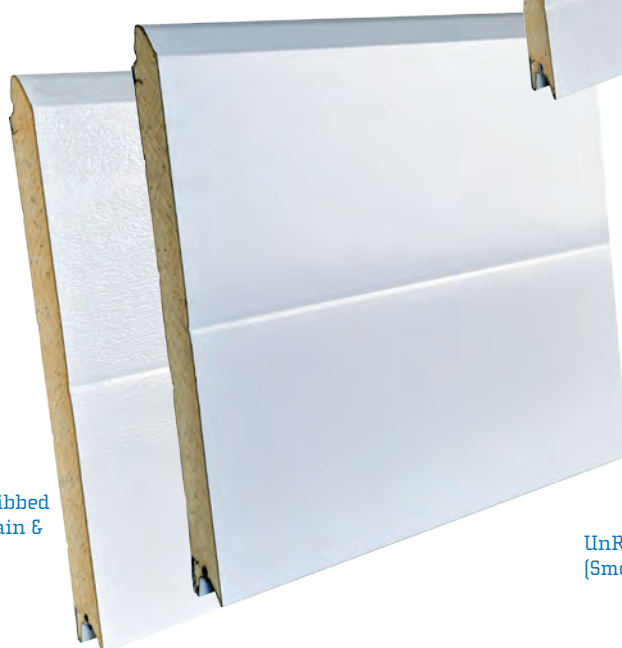

UnRibbed
(Smooth)

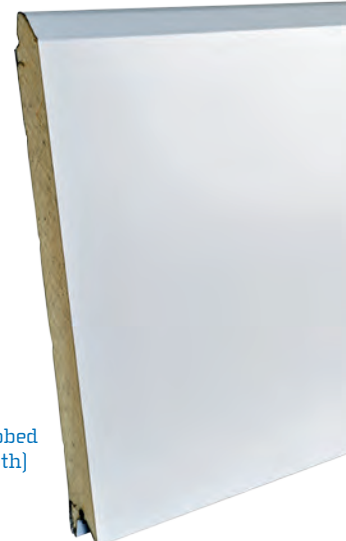



The 40 mm door panels provide an insulation value of 0.6 W/m²k

Convenience



Park right up to the door

Sectional garage doors operate vertically, travelling up and back into overhead tracks. Not only does this mean you can park right up to the garage door, you also gain extra drive through width and height compared to a traditional up and over door.



AlluGuard sectional doors are unique - each one is made-to-measure!



Centre Ribbed

Unribbed

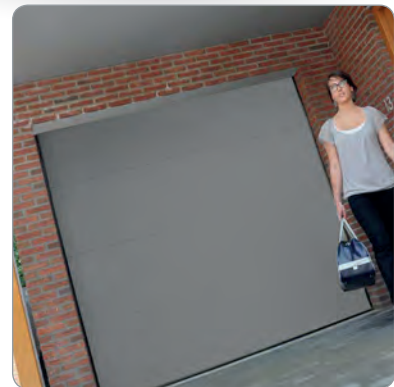

Unribbed in pale grey



Centre Ribbed in black

Spoilt for choice!

The perfect sectional garage door

Choose your panel type

There are 4 panel options to choose from, including the popular Georgian design and more contemporary options such as the centre ribbed and unribbed panels.



Ribbed

Georgian

Choose your Finish

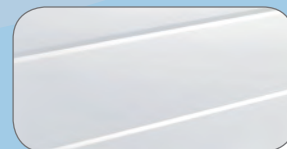

Smooth

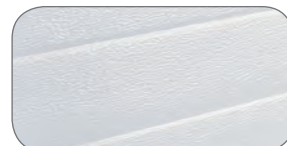

Woodgrain Texture
Embossed



Wood Effect*
*Foil and paint
woodgrain colours



Georgian in golden oak



Ribbed in Anthracite

Colours & options

Choose your colour

We've put together a list of our most popular finishes and standard colours for you to choose from, including our popular woodgrain finishes.

Colours shown are for guide purposes only and are limited by the printing process. Please ask to see a colour sample to confirm your choice.

Standard Colours

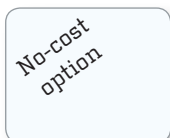

White



Anthracite Dura

Popular Colours



Moss Green RAL 6005



Fir Green RAL 6009



Steel Blue RAL 5011



Light Blue RAL 5015



Flame Red RAL 3000



Red RAL 3003



Anthracite RAL 7016



Heritage Green RAL 6021



Traffic White RAL 9016



Brown RAL 8014



Light Brown RAL 8001



Light Grey RAL 7035



Window Grey RAL 7040



White Aluminium RAL 9006



Duck Egg Blue BS 16 C 33



Grey Aluminium RAL 9007



Black RAL 9005



Light Ivory RAL 1015



Stone Grey RAL 7030



Terra Brown RAL 8028



Clay Brown RAL 8003



Pigeon Blue RAL 5014



Chartwell Green BS 14 C 35

Metallic Colours

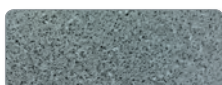

Titanium Silver



Sand Grey



Olive Grey Green



Steel Blue

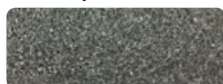

Leather Brown



Midnight Black



Noble Blue Grey



Onyx Black

Wood Effect Colours



Rosewood painted



Dark Oak painted



Irish Oak painted



Golden Oak painted



Golden Oak foiled
(Centre Ribbed only)



Something more bespoke?

If you're looking for something a little more bespoke, ask your garage door specialist and pick out your own colour from a choice of 100s of RAL colours. Speak to your garage door specialist about where and how you'd like your accessories to be positioned.



AlluGuard ribbed sectional insulated door in dark oak

Accessories

Become the envy of all with stunning accessory options such as silver effect handles, stainless steel porthole windows and glazing options.

Glazing

PVC (white/black) with polycarbonate windows OR Steel (round/square) with clear or frosted glass windows.



Handles

Both black and silver effect are available



AlluGuard sectional insulated door with porthole style windows



Lifting gear

All of our sectional garage doors come complete with a comprehensive warranty.



SE Side Mounted System

Neat, efficient.

The AlluGuard Sectional SE side mounted System really is a smooth operator. With optional automation, you'll be pleasantly surprised by how quiet the door is in operation.

Available on doors up to 3.2 metres wide, the SE is supplied made-to-measure, ensuring the perfect fit for your garage door opening. And, with our integrated weather-seals around each edge, there's no need to worry about rain ingress or drafts. It requires just 100mm headroom to fit inside your garage - it's one of the most compact doors on the market!

The 40 mm thick insulated panels keep the worst of the weather outside meaning you can make the most of your garage, all year round.

Choose from realistic woodgrains, classic heritage and contemporary colours or our range of contemporary shades such as anthracite.

RT Rear Mounted System (manual door not available)

Low on headroom? RT is the answer.

We've squeezed an extra 40mm clearance on our RT sectional door making it the perfect choice for garages that suffer from obscured or lower ceiling heights than standard garages. Our RT door comes with all the same great features as our standard model, but with added clearance.

Although 40 mm may not sound like a lot, it can have a big impact on how much of your garage is taken up by the more traditional garage doors. Our low-headroom sectional door is available in the same range of finishes, colours and style. Allowing you to choose the perfect door for your home, without compromise.

FT Front Mounted System

Make it a double. Suitable for openings up to 5.20 metres.

Whether you're replacing an existing double garage door or looking to knock two separate garages into one, the AlluGuard FT Sectional offers all the advantages of our standard sectional door but up to widths of 5.20 metres.

Supplied with optional automation and with the full range of colours, finishes and styles on offer, you can create your perfect garage door and have it made-to-measure.

Remote Control

Quality

The Sommer Base+ operator is a true next generation drive for the AlluGuard sectional garage door. Remote control has never been easier or more reliable.

- Saves power: <1 watt standby
- Made in Germany
- Integrated LED technology: durable, energy-saving and efficient lighting

Secure

The motor has automatic locking and active “push-back”-pressure if an attempt is made to force the door upwards.

A Bi-directional, secure SOMloq2 radio system keeps operation secure.

Safe

Automatic learning process: self-learning force curve with continual adjustment e.g. summer / winter operation ensures the door operates safely and reacts instantly to an obstruction to all European safety standards.



All AlluGuard sectional garage doors are available fitted, with the Sommer Base+ garage door operator

Automation Accessories



ENTRAsys GD Finger Print Scanner

Your fingerprint gives you access - store up to 80 finger prints.



Battery Backup

Allows your door to operate for 6-10 operations over a 12 hour period during a power-cut.



Telecody+ Digital wireless key pad

Just punch in the code and the door opens without the need for a handset.



Sleek Design

The interior of every door is completed with a white stucco finish giving your door a cleaner finish and style inside and out.



The ultimate space saver

The low headroom options make this the ideal choice for any garage space.



Security built in

The security & locking system built into the AlluGuard Sectional ensures security and peace-of-mind.

Features at a glance

4



Fingersafe joints

Each joint features a finger safe design ensuring that fingers cannot be caught or trapped between the panels, offering complete peace-of-mind.

5

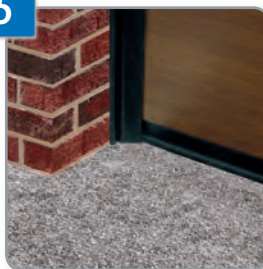

All weather shield

Substantial seals reaching 30 mm into the opening at the top, sides and bottom of the door protect against wind and rain and provide an all-weather superior seal for your home.

6

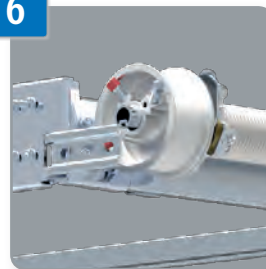

Safety first

Anti spring break devices ensure complete safety.

7



Energy efficient

The 40 mm Polyisocyanurate (PIR) insulated door panels provide an insulation value of 0.6 W/m²k, ensuring your home is energy efficient and saving you money. The panels also reduce noise and provide a sound reduction.

8



Complete convenience

With smooth automatic operation, your unique security code, in-built courtesy light and optional battery backup.

9



Smart connect

The unique smart connect connection system on all doors, ensures smooth operation, strong joints and long lasting stability.



Operator

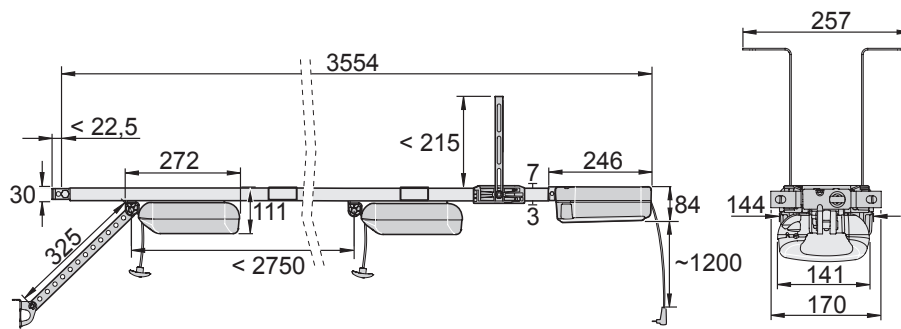

Sectional

SE Gear

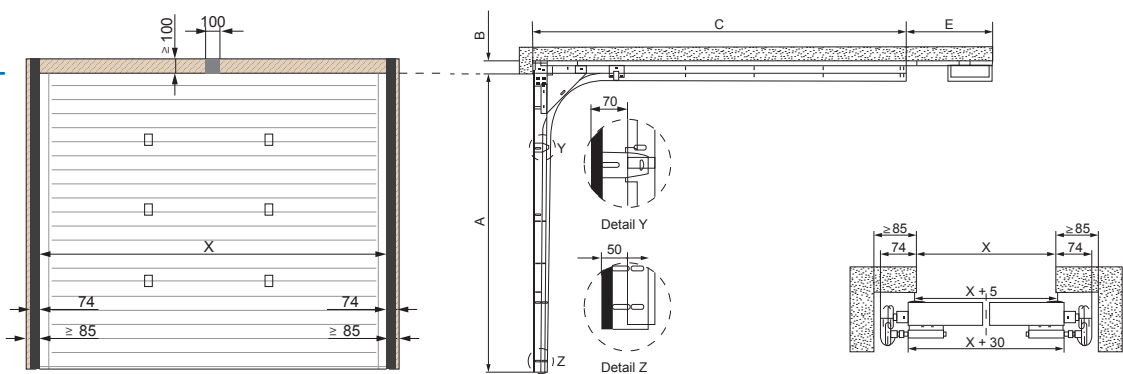

Necessary fixing surface		A	Daylight height	C	C + E	C Minimum	A + 375	
Sideroom & Headroom requirement			B	Free Headroom	$\geq 100\text{mm}$	C + E Minimum	A + 375 + E(800)	
Motor rail on lintel			C	Free mounting depth	2725 (A > 2000 - 2125 mm)	3325mm		
					2850 (A > 2125 - 2250 mm)	3575mm	Panel thickness	40mm
					2975 (A > 2250 - 2375 mm)	3575mm	Free sideroom	85mm
A	2000 2125 2250 2375	E	Extra mounting depth for motor				Door hangdown below daylight (manual)	230mm
		G	Door weight				Door hangdown below daylight (motor)	20mm
		W	Door surface				Track below daylight (A)	50mm
		X	Daylight width					
X=	2250 2400 2500 2750							

Technical

FT Gear

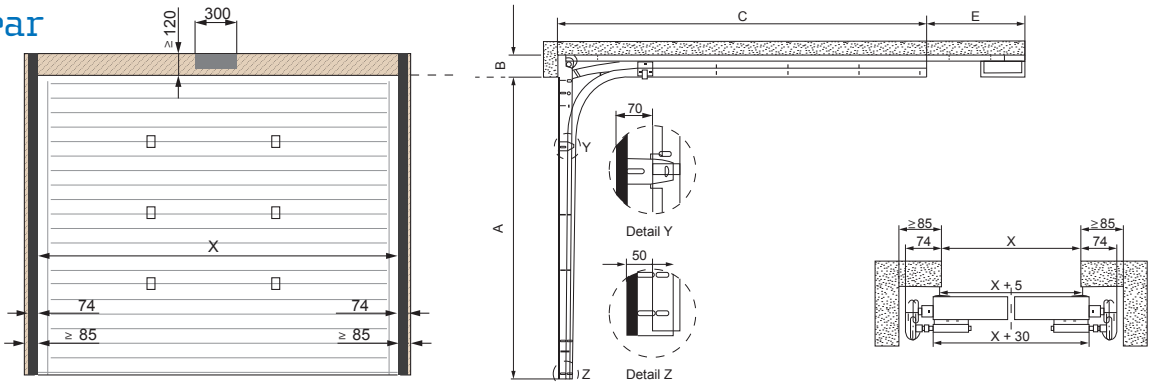

<ul style="list-style-type: none"> Necessary fixing surface Sideroom & Headroom requirement Motor rail on lintel 	A	Daylight height	$\geq 2500\text{mm}$	C + D	C + D + E	C Minimum	$A + 375$
	B	Free Headroom	$\geq 160\text{mm}$			C + E Minimum	$A + 375 + E$ (800mm)
	C	Free mounting depth		2605 (A > 2000 - 2125 mm)	3325mm	Panel thickness	40mm
	E	Extra mounting depth for motor		2730 (A > 2125 - 2250 mm)	3575mm	Free sideroom	85mm
	G	Door weight	$\leq 165\text{Kg}$	2855 (A > 2250 - 2375 mm)	3575mm	Door hangdown below daylight (manual)	170mm
	W	Door surface	$\leq 15.50\text{m}^2$	2980 (A > 2375 - 2500 mm)	3575mm	Door hangdown below daylight (motor)	0mm
	X	Daylight width	$\leq 5000\text{mm}$			Track below daylight (A)	10mm

RT Gear

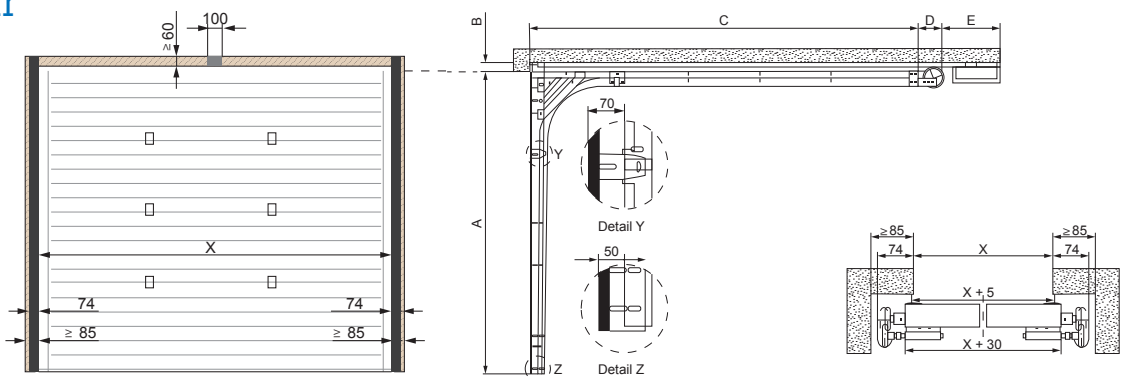

<ul style="list-style-type: none"> Necessary fixing surface Sideroom & Headroom requirement Motor rail on lintel 	A	Daylight height	$\geq 3000\text{mm}$	C + D	C + D + E	C + D Minimum	$A + 380 + D$
	B	Free Headroom	$\geq 60\text{mm}$			C + D + E Minimum	$A + 480 + D + E$ (800)
	C	Free mounting depth		2725 + D (A > 2000 - 2125 mm)	3325mm	Panel thickness	40mm
	D	Extra mounting depth for springs	170mm	2850 + D (A > 2125 - 2250 mm)	3575mm	Free sideroom	85mm
	E	Extra mounting depth for motor		2975 + D (A > 2250 - 2375 mm)	3575mm	Door hangdown below daylight	85mm
	G	Door weight	$\leq 300\text{Kg}$	3100 + D (A > 2375 - 2500 mm)	4335mm	Track below daylight (A)	110mm
	W	Door surface	$\leq 18.00\text{m}^2$	3350 + D (A > 2500 - 2750 mm)	4335mm		
	X	Daylight width	$\leq 6000\text{mm}$	3600 + D (A > 2750 - 3000 mm)	4335mm		

Safety - CE marking

It is against the law to install a power operated garage door in the UK without complying with The Machinery Directive.

To comply with the Machinery Directive both the door and the motor and controller used in the installation must have a Declaration of Incorporation from the manufacturer.

On completion of the installation the installer must provide a Declaration of Conformity and apply a CE mark giving details of the installation to the door / motor and controller combination, which is now classed as a machine.

The installer must issue to the customer a Declaration of Conformity, maintenance and operation instructions on the completion of the installation.

The installer must hold copies of both the Declaration of Incorporation and the Declaration of Conformity on a technical file for inspection by the relevant authorities.

If any of the above requirements are not fulfilled the Installation is illegal and may be unsafe.

Please ensure for your own safety and peace-of-mind that whoever installs your electric motor and controller is both willing and able to fulfil these requirements; if they are not – do not use them.

Choose a member of the DHF Garage Door Installer Group who CAN and WILL install your motor and controller safely and legally.

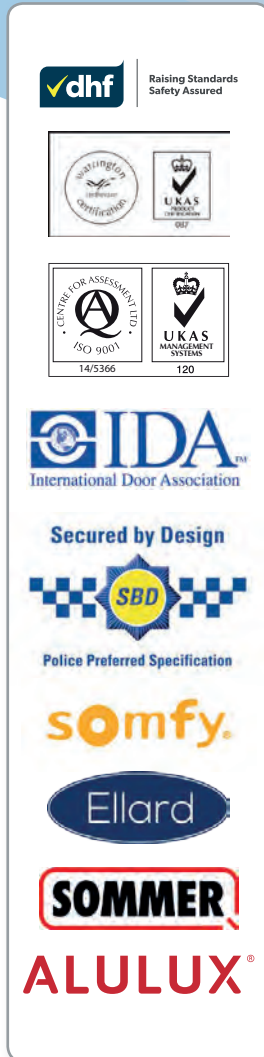

Peace-of-Mind Warranties

- (a) AlluGuard roller garage doors are guaranteed against any form of manufacturing defect for a period of 2 years from the date of original purchase.
- (b) AlluGuard tubular motors are guaranteed against any form of manufacturing defect for a period of 5 years. Other electrical and mechanical elements within the control system are guaranteed for a period of 5 years.
- (c) AlluGuard roller garage doors exterior finish is guaranteed to provide an effective weatherproof membrane that will resist perforation of the substrate from the weather side due to corrosion for a period of 5 years. Colour change or fade to the exterior surface will be limited and uniform during the guarantee period.
- (d) AlluGuard sectional garage doors are guaranteed against defect of material or workmanship by AlluGuard with a parts only warranty, subject to correct installation, maintenance and operation, for a period of 10 years from the date of purchase.

Guarantees are subject to conditions - please visit www.alluguard.co.uk/warranty for full details



AlluGuard Limited
Rotherham Road, Parkgate, Rotherham S62 6FP
t: 01709 529 723
f: 01709 524 577
e: info@alluguard.co.uk
w: www.alluguard.co.uk